



**HEAD OFFICE** 20 ARTHUR STREET NORTH, ELMIRA, ONTARIO N3B 1Z9  
 TEL: (519) 669-4025 FAX: (519) 669-1436

**ORDER DESK** e-mail: [orders@walcoequipment.com](mailto:orders@walcoequipment.com)  
 TEL: (519) 669-1401 FAX (519) 669-3499

**QUEBEC OFFICE** 364 RTE.122 ST. GERMAIN DE GRANTHAM, QUÉBEC J0C 1K0  
 TEL: (819) 395-5115 Fax (819) 395-2624  
 e-mail: [walcoqc@walcoequipment.com](mailto:walcoqc@walcoequipment.com)

SECTION

T

PAGE 1

## TRYGG FAST TRAC

TIRE CHAIN  
SOLD / SET

2021

**EXTRA STRONG**  
7mm CHAIN  
for SNOW REMOVAL  
& ROAD WORK



ITEM #	TIRE SIZE	CHAIN SIZE	LIST PRICE
507161	16.9-38	18.4x30	18.4x34
	480/70-30	480/70-34	480/70-38
	480/80-30	480/80-38	520/70-30
	520/70-34	540/65-30	540/65-34
	540/65-38	540/70-30	540/70-34
507162	14.9 x 28	14.9x30	15.5x38
	18.4x26	380/85/2	380/85-30
	385/95-25	420/70-30	420/70-34
	420/85-28	420/85-30	420/85-34
	440/80-26	440/80-30	420/80-34
	480/65-28	480/70-28	
	16.9 x 24	17.5 x 24	16.9 x 30
	507163	14.9x20	14.9x24
507164	360/70-24	360/70-28	360/80-24
	365/80-20	365/85-20	375/75-20
	380/70-20	380/70-24	380/70-28
	380/85-24	395/80-20	400/80-24
	405/70-18	405/70-20	405/70-24
	420/65-20	44 x 80 x 20	15 x 19.5
	11.2x28	12.4x24	12.4x28
	13.6x24	13.6x28	280/85-28
	300/70-24	320/70-24	320/70-28
	320/85-24	320/85-28	340/80-24
	340/85-24		

**SUPERB TRACTION**

**SMT**

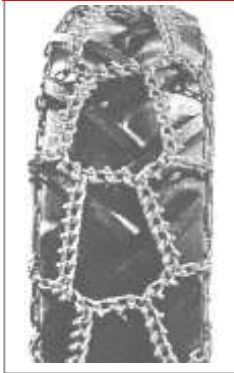

## TRACTOR TIRE CHAIN - SMT STUDDED

ALL PURPOSE, ALL TERRAIN, STUDDED CHAIN, FOR ALL TIRE SIZES FOR ICE ROCK MUD OR DEEP SNOW

ITEM #	TIRE SIZE	CHAIN SIZE	LIST PRICE
507200	11.2 X 24	5/16"	
507201	11.2 x 28	5/16"	
507202	12.4 X 24	3/8"	
507203	12.4 X 28	3/8"	
507204	13.6 X 24	3/8"	
507205	13.6 X 28	3/8"	
507206	14.9 X 24	3/8"	
507208	16.9 x 24, 14.9 X 28, 420/70R24	3/8	
507209	16.9 X 28	3/8"	
507210	16.9 X 30	3/8"	
507211	18.4 X 30	3/8"	
507212	18.4 X 34	3/8"	
507213	18.4 x 38	3/8"	
507215	20.8 X 38	3/8"	

◆◆◆ Other sizes available on request ◆◆◆ PRICES SUBJECT TO CHANGE WITHOUT NOTICE

## TWINWAY-SIX TRACTOR CHAIN

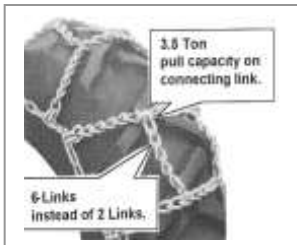

ITEM #	SIZE	STOCK #	LIST PRICE
506073	13.6-26, 13.6-28, 14.9-24, 14.9-26	6-9373	
506074	14.9-28	6-9374	
506076	13.6-36	6-9376	
506077	13.6-38	6-9377	
506078	14.9-38	6-9378	
506087	16.9-24, 17.5L-24	6-9387	
506089	16.9-28, 19.5L-24	6-9389	
506090	16.9-30, 18.4-26	6-9390	
506091	16.9-32, 18.4-28	6-9391	
506092	16.9-34, 18.4-30, 15.5-38	6-9392	
506094	18.4-34, 16.9-38	6-9394	
506095	18.4 x 42	6-9395	
506096	18.4-38	6-9396	
506097	20.8-34, 23.1-26, 23.1-30	6-9397	
506098	23.1-34, 20.8-38	6-9398	

PRICES SUBJECT TO CHANGE WITHOUT NOTICE

See term schedule for dealer discounts. All prices F.O.B. Elmira ON, and subject to change without notice. Tax extra.



**HEAD OFFICE** 20 ARTHUR STREET NORTH, ELMIRA, ONTARIO N3B 1Z9  
 TEL: (519) 669-4025 FAX: (519) 669-1436

**ORDER DESK** e-mail: [orders@walcoequipment.com](mailto:orders@walcoequipment.com)  
 TEL: (519) 669-1401 FAX (519) 669-3499

**QUEBEC OFFICE** 364 RTE.122 ST. GERMAIN DE GRANTHAM, QUÉBEC J0C 1K0  
 TEL: (819) 395-5115 Fax (819) 395-2624  
 e-mail: [walcoqc@walcoequipment.com](mailto:walcoqc@walcoequipment.com)

SECTION

T

PAGE 2

**TWINWAY-SIX STUDDED TRACTOR CHAIN**

2021

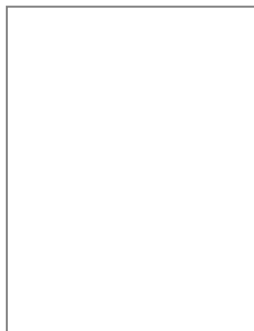

**TWINWAY-SIX  
 WITH  
 STUDDED  
 SECTIONS**

ITEM #	TIRE SIZE	STOCK#	LIST PRICE
506122	11.2-24		
506121	9.5-32, 11.2-28, 12.4-24, 15 x 19.5, 10 x 28		
506120	9.5-40, 11.2-36		
506119	9.5-36, 11.2-32, 12.4-28, 9.5-42, 11.2-38, 11.2-40, 12.4-36, 12.4-38		
506118	13.6x24, 13.6-26, 13.6-28, 14.9-24, 14.9-26,		
506117	14.9-28, 420/70R24		
506116	13.6-36, 14.9x30, 14.9x38		
506115	16.9-24, 17.5L-24		
506114	16.9-28, 18.4-24, 19.5L-24		
506113	16.9-30, 18.4-26, 16.9-32, 18.4-28		
506111	16.9-34, 18.4-30, 15.5-38		
506110	18.4-34, 16.9-38		
506109	18.4-38		

TIRE CHAIN  
 SOLD / SET

**TWINWAY-TWO TRACTOR CHAIN**

**3/8 CROSS CHAIN**

ITEM #	TIRE SIZE	STOCK#	LIST PRICE
502036	11.2-24	2-9336	
502038	9.5-32, 11.2-28, 12.4-24, 15 x 19.5, 10 x 28	2-9338	
502042	9.5-36, 11.2-32, 12.4-28	2-9342	
502046	9.5-40, 11.2-36	2-9346	
502048	9.5-42, 11.2-38, 11.2-40, 12.4-36, 12.4-38	2-9348	
502073	13.6-26, 13.6-28, 14.9-24, 14.9-26	2-9373	
502074	14.9-28, 420/70R24	2-9374	
502076	13.6-36, 14.9x30	2-9376	
502077	13.6-38	2-9377	
502079	14.9-38	2-9379	
502080	14.9x46		
502087	16.9-24, 17.5L-24	2-9387	
502089	16.9-28, 18.4-24, 19.5L-24	2-9389	
502090	16.9-30, 18.4-26	2-9390	
502091	16.9-32, 18.4-28	2-9391	
502092	16.9-34, 18.4-30, 15.5-38	2-9392	
502094	18.4-34, 16.9-38	2-9394	
502095	18.4 x 42	2-9395	
502096	18.4-38	2-9396	
502097	20.8-34, 23.1-26, 23.1-30	2-9397	
502098	23.1-34, 20.8-38	2-9398	

**TWINWAY-TWO  
 WITH 3/8 V-BAR  
 CROSS CHAIN**



ITEM #	TIRE SIZE	STOCK#	LIST PRICE
502136	11.2-24	2-9336	
502138	9.5-32, 11.2-28, 12.4-24, 15 x 19.5, 10 x 28	2-9338	
502142	9.5-36, 11.2-32, 12.4-28	2-9342	
502146	9.5-40, 11.2-36	2-9346	
502148	9.5-42, 11.2-38, 11.2-40, 12.4-36, 12.4-38	2-9348	
502173	13.6-26, 13.6-28, 14.9-24, 14.9-26	2-9373	
502174	14.9-28, 420/70R24	2-9374	
502176	13.6-36, 14.9x30	2-9376	
502177	13.6-38	2-9377	
502179	14.9-38	2-9379	
502187	16.9-24, 17.5L-24	2-9387	
502189	16.9-28, 18.4-24, 19.5L-24	2-9389	
502190	16.9-30, 18.4-26	2-9390	
502191	16.9-32, 18.4-28	2-9391	
502192	16.9-34, 18.4-30, 15.5-38	2-9392	
502194	18.4-34, 16.9-38	2-9394	
502195	18.4 x 42	2-9395	
502196	18.4-38	2-9396	
502198	23.1-34, 20.8-38	2-9398	



**HEAD OFFICE** 20 ARTHUR STREET NORTH, ELMIRA, ONTARIO N3B 1Z9  
 TEL: (519) 669-4025 FAX: (519) 669-1436

**ORDER DESK** e-mail: [orders@walcoequipment.com](mailto:orders@walcoequipment.com)  
 TEL: (519) 669-1401 FAX (519) 669-3499

**QUEBEC OFFICE** 364 RTE.122 ST. GERMAIN DE GRANTHAM, QUÉBEC J0C 1K0  
 TEL: (819) 395-5115 Fax (819) 395-2624  
 e-mail: [walcoqc@walcoequipment.com](mailto:walcoqc@walcoequipment.com)

SECTION

T

PAGE 3

## LAWN & GARDEN TRACTOR CHAIN

2021

### 2-LINK SPACING 7/32"

4 Link Spacing available on request

ITEM #	TIRE SIZE	LIST PRICE
520101	16 x 6.50 x 8	
518127	16 x 7.50 x 8	
520100	18 x 6.50 x 8	

520098	18 x 7.50 x 8	
520102	18 x 8.50 x 8	
520103	18 x 9.50 x 8	
518214	18 x 8.50 x 10	
520129	20 x 8.00 x 8	
520105	20 x 10.0 x 8	
520106	20 x 10.0 x 10	

520181	22 x 11 x 10	
520107	20.5 x 8 x 10	
520148	21 x 7.00 x 10	

520111	22 x 7.50 x 12	
520166	22 x 8.00 x 12	
520113	22 x 9.00 x 12	

520112	23 x 8.50 x 12	
520183	22 x 9.50 x 12	
520114	23 x 9.50 x 12	

520120	23 x 10.5 x 12	
520115	23 x 12.50 x 12	
520177	24 x 10.50 x 12	
520138	24 x 12 x 12	

520168	25 x 8.50 x 14	
520211	25 x 12 x 9	
520154	23 x 8.50 x 14	
520122	26 x 12.00 x 12	

### 4 LINK SPACING 5/16"

ITEM #	TIRE SIZE	LIST PRICE
520201	7 x 16 Case Hardened	
520128	8.3 x 16 Case Hardened	

520215	800 x 18 Turf Case Hardened	
520147	9.5 x 16 Case Hardened	

520301	9.5 x 24 Case Hardened	
508027	10R 165 Case H. Also for Fork Lift	

520306	12.4 x 16 Case Hardened	
508054	12 R x 165 Case Hardened	

520212	13.6 x 16 Case Hardened	
520308	18.4 x 16.1 Case Hardened	

520302	43 x 13.5 22 Case Hardened	
520176	44 x 18 x 20 Case Hardened	

520219	41 x 14.00 x 20 Case Hardened	
520310	355 x 80-D x 20 Case Hardened	
520421	43 x 16 x 20 Case Hardened	
508459	27 x 10.50x 15	

### 2-LINK SPACING 7/32"

4 Link Spacing available on request

ITEM #	TIRE SIZE	LIST PRICE
520121	27 x 8.50 x 15	
520125	27 x 9.50 x 15	

520130	29 x 12.00 x 15	
520135	31 x 13.50 x 15	

520140	31 x 15.5 x 15	
520311	212 x 80-D x 15	

520213	33 x 12.50 x 15	
520171	41 x 14.00 x 20	

520206	25 x 10 x 12	
--------	--------------	--

520205	24 x 8.5 x 12	
520131	29 x 12.5 x 15	

520141	7 x 16 Case Hardened	
520146	8.3 x 16 Case Hardened	

520144	9.50 x 16 Case Hardened	
508129	12 x 16.5 LT Case Hardened	

520305	12.4 x 16 Case Hardened	
520150	13.6 x 16 Case Hardened	

520216	35 x 12.00 x 15 Case Hardened	
520214	36 x 13.50 x 15 Case Hardened	

508430	43 x 13.5 x 22 Case Hardened	
520175	44 x 18 x 20 Case Hardened	

PRICES SUBJECT TO CHANGE WITHOUT NOTICE

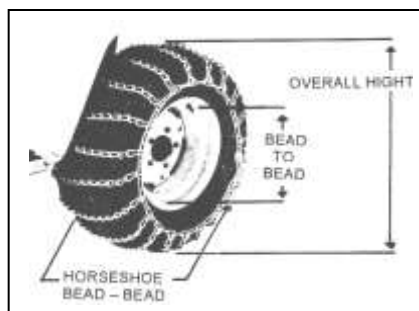

Three dimensions are needed as shown below, if your tire size is not on the price list.



V-Bar Cross Chain available @ extra cost



**HEAD OFFICE** 20 ARTHUR STREET NORTH, ELMIRA, ONTARIO N3B 1Z9  
 TEL: (519) 669-4025 FAX: (519) 669-1436  
**ORDER DESK** e-mail: [orders@walcoequipment.com](mailto:orders@walcoequipment.com)  
 TEL: (519) 669-1401 FAX (519) 669-3499  
**QUEBEC OFFICE** 364 RTE.122 ST. GERMAIN DE GRANTHAM, QUÉBEC J0C 1K0  
 TEL: (819) 395-5115 Fax (819) 395-2624  
 e-mail: [walcoqc@walcoequipment.com](mailto:walcoqc@walcoequipment.com)

SECTION

T

PAGE 4

## STANDARD TIRE CHAIN

TIRE CHAIN  
SOLD / SET

2021

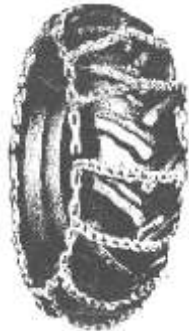

CASE HARDENED CROSS-CHAIN		4-LINK SPACING		2-LINK SPACING	
TIRE SIZE	ITEM #	3/8" LIST		ITEM #	3/8" LIST
11.2-10 X 24	508102			508130	
11.2-10 X 28	508113			508124	
11.2-10 X 32	508125				
11.2-10 X 34					
11.2 10 X 36	508122				
12.4-11X 24	508114			508119	
12.4-11 X 28	508116			508117	
12.4-11 X 32					
12.4-11 X 36				508118	
12.4-11 X 38	508196				
13.6-12 X 24	508131			508142	
13.6-12 X 28	508133			508148	
13.6-12 X 36					
13.6-12 X 38					
14.9-13 X 24	508135			508139	
14.9-13 X 28	508137			508170	
14.9-13 X 30					
14.9-13 X 38					
16.9-14 X 24	508151			508149	
16.9-14 X 26				508147	
16.9-14 X 28	508152				
16.9-14 X 30	508154			508155	
16.9-14 X 32					
16.9-14 X 34					
16.9-14 X 38					

4-LINK SPACING				2-LINK SPACING			
TIRE SIZE	ITEM #	3/8" LIST	7/16" LIST	ITEM #	3/8" LIST	ITEM #	7/16" LIST
18.4-15 X 26	508165		xxxxxx		xxxxxx		
18.4-15 X 30	508157		508159		xxxxxx		
18.4-15 X 34	508158		xxxxxx		xxxxxx		
18.4-15 X 38	508169		xxxxxx		508168		

## SNOW BLOWER TIRE CHAIN 4mm 2-LINK SPACING

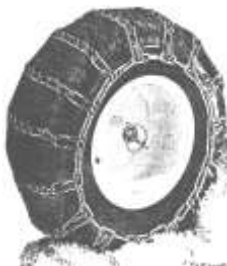

ITEM #	TIRE SIZE	LIST PRICE
518116	10 x 2.75	
518104	10.25 x 3.25	
518106	12 x 4.00 x 6	
518107	12 x 3.50 x 6	
520001	4.10 x 3.50 x 4	
520005	4.10 x 3.50 x 6	
520004	13.00 x 5.00 x 6	
518115	5.30 x 4.50 x 6	
518118	12.50 x 4.50 x 6	
520007	4.80 x 4.00 x 8	
520006	13 x 6.50 x 6	
520002	15 x 6.00 x 6	
520011	13 x 4.00 x 6	

## SNOW HOG - ZIG ZAG 4mm



ITEM #	TIRE SIZE	LIST PRICE
518120	4.10 x 3.50 x 4	
518121	5.3 x 6	
518122	4.8 x 4.00 x 8	
520012	15.00 x 6 x 6	
518123	16 x 6.50 x 8	
518124	13.5 x 500 x 6	
520013	15 x 5 x 6	
518128	4.10 x 6	
518132	14 x 4 x 6	

PRICES SUBJECT TO CHANGE WITHOUT NOTICE



**HEAD OFFICE** 20 ARTHUR STREET NORTH, ELMIRA, ONTARIO N3B 1Z9  
 TEL: (519) 669-4025 FAX: (519) 669-1436

**ORDER DESK** e-mail: [orders@walcoequipment.com](mailto:orders@walcoequipment.com)  
 TEL: (519) 669-1401 FAX (519) 669-3499

**QUEBEC OFFICE** 364 RTE.122 ST. GERMAIN DE GRANTHAM, QUÉBEC J0C 1K0  
 TEL: (819) 395-5115 Fax (819) 395-2624  
 e-mail: [walcoqc@walcoequipment.com](mailto:walcoqc@walcoequipment.com)

SECTION  
**T**  
 PAGE 5

## ATV TIRE CHAIN V-Bar

2021



TIRE CHAIN  
 SOLD / SET

ITEM #	TIRE SIZE	LIST PRICE
	22 X 8 X 10 / 21 X 7 X 10	
	20 X 11 X 8	
525006	21 x 11 x 8 Ht 20 Rim 9 Hs 21	
525001	22 X 11 X 8 / 22 X 12 X 8	14 cross chain
525003	25 x 8 x 12	14 cross chains
525004	25 x 10 x 12	14 cross chains
525015	25 X 12 X 9	
525005	24 x 11 x 10	14 cross chain
525020	25 X 13 X 9 Hr 25 Rim 10 Hs 22	14 cross chains
520241	23 x 10.5 x 12	14 cross chains
525010	24 X 9 X 11	
518405	18 x 8.5 x 10	
520182	26 x 12 x 12	
520236	20 x 10 x 8	
520362	22 x 11 x 10	

## FORK-LIFT TIRE CHAIN

**CASE HARDENED CROSS-CHAIN, 2-LINK SPACING.**

V-Bar available @ additional cost



ITEM #	TIRE SIZE	LIST PRICE
508050	6.50 x 10	7/32"
508074	7.50 x 10	7/32"
508073	900 x 10	7/32"
508004	700 x 12	7/32"
508005	700 x 15	7/32"
508002	750 x 15 x 30 & 32	7/32"
508067	28 x 9 x 15	7/32"
508077	250 x 15	7/32"
508015	7.50 x 15 x 30	5/16"
508039	7 x 12	5/16"
508008	825 x 15	5/16"
508048	750 x 16	5/16"
508047	32 x 12.1 x 15	5/16"
508068	28 x 12.50 x 15	5/16"
508059	28 x 9 x 15	5/16"
508044	31 x 10.50 x 15	5/16"
508090	27 x 10.50 x 15	5/16"

## SKID STEER TIRE CHAIN

ITEM #	TIRE SIZE	CHAIN SIZE	LIST PRICE
<b>2-LINK SPACING - CASE HARDENED</b>			
508128	10R 165	5/16"	
508040	12R 165	5/16"	
508127	14 x 17.5	5/16"	
508126	15 x 19.5	5/16"	

## 4-LINK SPACING - CASE HARDENED

ITEM #	TIRE SIZE	CHAIN SIZE	LIST PRICE
508027	10R 165	5/16	
508054	12R 165	5/16	
508143	14 x 17.5	5/16"	
508094	15 x 19.5	5/16	

PRICES SUBJECT TO CHANGE WITHOUT NOTICE

# TIRE CHAIN PARTS & ACCESSORIES

2021



ITEM #	DESCRIPTION			LIST PRICE / FT.
500039	5/32" /4mm	Zinc	Cross Chain	
500055	7/32"	Zinc	Cross Chain	
500053	7/32"	Case Hardened	Cross Chain	
500061	1/4"	Case Hardened	Cross Chain	
500081	5/16"	Case Hardened	Cross Chain	
500096	3/8" /9.5mm	Case Hardened	Cross Chain	
505115	7/16"	Case Hardened	Cross Chain	
500130	1/2"	Case Hardened	Cross Chain	
500205	5.5mm	Case Hardened	Cross Chain Studded	
500206	9/32"	Case Hardened	Cross Chain Studded	
500208	5/16"	Case Hardened	Cross Chain Studded	
500210	3/8"	Case Hardened	Cross Chain Studded	
500211	7/16"	Case Hardened	Cross Chain Studded	
500213	1/2"	Case Hardened	Cross Chain Studded	
500310	3/8"	Square Link	Cross Chain	
500311	7/16"	Square Link	Cross Chain	
500406	5.5 mm	Zinc	V-bar cross chain	
500407	5/16"	Self colour	V-bar cross chain	
501039	5/32 / 4mm	Zinc 30 mm link	Side Chain	
501038	5/32 /4mm	Zinc	Side Chain	
599999	3/16"	Zinc	Side Chain	
501086	5/16"	Regular	Side Chain	
501102	3/8"	Regular	Side Chain	
501125	7/16"	Regular	Side Chain	
501130	1/2"	Regular	Side Chain	
505135	<b>Chain Pliers</b> - handle 26" long - overall 33" long			
505134	<b>Chain Pliers</b> for Lawn & Garden - overall length 13"			
503210	10mm	Hardened Connect /S-Link for 5/16 Trygg cross chain		
503211	11mm	Hardened Connect /S-Link for 11/32 Trygg cross chain		
503212	12mm	Hardened Connect /S-Link for 3/8 Trygg cross chain		
503214	14mm	Hardened Connect /S-Link for 7/16 Trygg cross chain		
505039	4mm	Cross Chain Hook		
505055	7/32"	Cross Chain Hook		
505063	1/4"	Cross Chain Hook		
505080	5/16"	Cross Chain Hook		
505062	3/8"	Cross Chain Hook		
505110	7/16"	Cross Chain Hook		
505130	1/2"	Cross Chain Hook		
503704	3/16"	Repair Link		
503706	1/4"	Repair Link		
503708	5/16"	Repair Link		
503710	3/8"	Repair Link		
503713	1/2"	Repair Link		
503402	1/8"	Quick Link		
503404	3/16"	Quick Link		
503406	1/4"	Quick Link		
503408	5/16"	Quick Link		
503410	3/8"	Quick Link		
503411	1/2"	Quick Link		
503009	#555	1/4" Side Chain Lock		
503015	#889	5/16" Side Chain Lock		
503014	#1011	3/8" Side Chain Lock		
503007	Wire Lock			
503016	#675	NA Lock - 5/16"		
503018	#714	NA Lock - 3/8"		
503004	#543	Lawn and Garden Outside Chain Lock		
503005	#500	Lawn and Garden Inside Lock		
503019	6-7mm	Lawn and Garden Inside Lock		
503008	7-9mm	Lawn and Garden Inside Lock		



**HEAD OFFICE** 20 ARTHUR STREET NORTH, ELMIRA, ONTARIO N3B 1Z9  
 TEL: (519) 669-4025 FAX: (519) 669-1436  
**ORDER DESK** e-mail: [orders@walcoequipment.com](mailto:orders@walcoequipment.com)  
 TEL: (519) 669-1401 FAX (519) 669-3499  
**QUEBEC OFFICE** 364 RTE.122 ST. GERMAIN DE GRANTHAM, QUÉBEC J0C 1K0  
 TEL: (819) 395-5115 Fax (819) 395-2624  
 e-mail: [walcoqc@walcoequipment.com](mailto:walcoqc@walcoequipment.com)

SECTION

T

PAGE 7

## TRUCK TIRE CHAIN

2021

TIRE CHAIN  
SOLD / SET

### SINGLE



TIRE SIZE 4-LINK	ITEM #	9/32 LIST PRICE	ITEM #	5/16 LIST PRICE	ITEM #	3/8"-9.5 LIST PRICE
10.00-20, 11-22.5	507950		508328		508342	
10-R-20, 11-R-22.5					508341	
10.00-22, 11-24.5	507951		508350		508357	
10-R-22, 11-R-24.5					508354	
11.00-20, 12-22.5			508360		508368	
11-R-20, 12-R-22.5						
12.00-20, 12-R-20			508382		508370	
12-24.5, 11-R-22			508403		508378	
11.00-22, 12-R-24.5						
445/50R 22.5			520294			
11.00-22, 12-R-24.5, 445/50R 22.5 with Cams			520293			
TIRE SIZE 2-LINK	ITEM #	5/16 LIST PRICE				
10 X 20	508332					

### ATV STYLE V-BAR with Cam Tightener



TIRE SIZE 4-LINK	ITEM #	9/32 LIST	ITEM #	5/16 LIST
10x20, 11x22.5	508427		508194	

Other Sizes Available with V-Bar Cross Chain

### DUAL



TIRE SIZE 4-LINK	ITEM #	9/32 LIST	ITEM #	5/16 LIST	ITEM #	3/8"-9.5 LIST
10.00-20, 11-22.5			508329		508330	
10-R-20, 11-R-22.5						
10.00-22, 11-24.5			508361		508400	
10-R-22, 11-R-24.5					508352	
11.00-20, 12-22.5			508380		508369	
11-R-20, 12-R-22.5			508424			
12.00-20, 12-R-20					508180	
12-24.5, 11-R-22						
11.00-22, 12-R-24.5						

### TRIPLE



TIRE SIZE 4-LINK	ITEM #	5/16 LIST	ITEM #	3/8 LIST	ITEM #	9.5 LIST
10.00-20, 11-22.5	508292				508343	
10-R- 20, 11-R-22.5						
10.00-22, 11-24.5	508326				508358	
10-R- 22, 11-R-24.5					508355	
11.00-20, 12-22.5					508367	
11-R- 20, 12-R-22.5	508395					
12.00-20, 12-R-20						
11.00-22, 12-R-24.5						
11-R-22, 12-R-24.5						

◆◆◆ OTHER SIZES AVAILABLE ◆◆◆

## CABLE TRUCK CHAINS

ITEM #	TIRE SIZE	LIST PRICE
508422	11RX22.5 Triple	
508414	900X20	

PRICES SUBJECT TO CHANGE WITHOUT NOTICE



**HEAD OFFICE** 20 ARTHUR STREET NORTH, ELMIRA, ONTARIO N3B 1Z9  
 TEL: (519) 669-4025 FAX: (519) 669-1436  
**ORDER DESK** e-mail: [orders@walcoequipment.com](mailto:orders@walcoequipment.com)  
 TEL: (519) 669-1401 FAX (519) 669-3499  
**QUEBEC OFFICE** 364 RTE.122 ST. GERMAIN DE GRANTHAM, QUÉBEC J0C 1K0  
 TEL: (819) 395-5115 Fax (819) 395-2624  
 e-mail: [walcoqc@walcoequipment.com](mailto:walcoqc@walcoequipment.com)

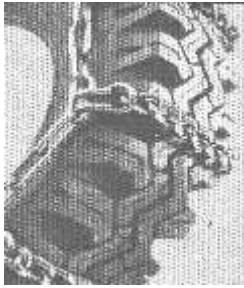

**TRUCK TIRE CHAIN**  
 For Radial & Bias Ply Tires

2021

TIRE CHAIN  
 SOLD / SET

ITEM #	TIRE SIZE	2-LINK 7/32	LIST PRICE	ITEM #	4 LINK 5/16	LIST PRICE
	5.6-15, 6.00-15, BR70-13, BR78-14, CR78-14, 175R14, 155R15, 165R15, 185/70R14, 175/70R14, 185/80R14, 185/80R13					
	CR70-13, 175R13, 185R13, 185/10R13, 195/70R13, 175/10R14, 165R14, 175/80R13					
	DR87-14, ER78-14, 185R14, 175R15, 195/70R14, 185/70R15, 205/70R13, 205/70R14, 195/75R14					
508049	205/70R14					
	FR70-14, FR78-14, GR78-14, FR78-15, 195R14, 185R15, 195R15, 215/70R14, 205/70R15, P205/75R14					
508299	GR70-14, HR70-14, GR70-15, HR78-14, GR78-15, HR78-15, 205R15, 225/70R15, 205/75R15, 215/70R15			520335		
	215/75R15			508021		
508081	225R15					
	LR78-15, L84-15, 215R15, 230R15, 225/75R15					
	H78-15, 8.00-R-16.5, 8.00-16.5, G78-G78-15, 225-75R14, 215-75R15					
508022	235-75R15,			508010		
	215-85R16			508011		
	L78-15, 8.75-16.5, 8.75-R-16.5, 235-15, 230-15, J78/JR78-15, 8.00-16.5 8.75-16.5			508098		
	9.5-16.5, 7.50-R16-17, 9.50-R16.5, 7.50-16/17 6.00-16, 6.70-15					
	6.50-16, 6.50-R-16					
	7.00-15/16, 7.50-15, 9.50-16.5, 7.17.5, 8-17.5, 700-R-15, 9.50-16.5, 8-R-17.5, 215/85-R-16					
508036	235/85-R-16			508086		
	7.50-16/17, 7.00-17/18, 7.50-18, 7-22.5, 8-19.5, 10-16.5, 7.00-20, 7.50-R-17, 8-R-19.5, 10-R-16.5, 255/85-r-16					
	7.00-20, 7.50-20, 8-22.5, 10-17.5 8.25-20, 9-22.5, 255/70-R-22.5, 8.25-R-20, 9-R-20.25					
520370	9.00-20, 10-22.5, 275/80-R-22.5, 9-R-20, 10-R-22.5					

PRICES SUBJECT TO CHANGE WITHOUT NOTICE

See term schedule for dealer discounts. All prices F.O.B. Elmira ON, and subject to change without notice. Tax extra.





**HEAD OFFICE** 20 ARTHUR STREET NORTH, ELMIRA, ONTARIO N3B 1Z9  
 TEL: (519) 669-4025 FAX: (519) 669-1436

**ORDER DESK** e-mail: [orders@walcoequipment.com](mailto:orders@walcoequipment.com)  
 TEL: (519) 669-1401 FAX (519) 669-3499

**QUEBEC OFFICE** 364 RTE.122 ST. GERMAIN DE GRANTHAM, QUÉBEC J0C 1K0  
 TEL: (819) 395-5115 Fax (819) 395-2624  
 e-mail: [walcoqc@walcoequipment.com](mailto:walcoqc@walcoequipment.com)

SECTION

T

PAGE 9

## LOADER & GRADER

2021

TIRE CHAIN  
SOLD / SET



2-LINK SPACING



4-LINK SPACING

### REGULAR LINK CROSS CHAIN - 2 LINK SPACING

(11mm)

TIRE SIZE	ITEM #	3/8" LIST	ITEM #	7/16" LIST
13.00 x 24	508202			
14.00 x 24	508221		508224	
16.00 x 24	508246		508260	
17.5 x 25	508231		508234	
20.5 x 25	508254		508240	
23.5 x 25	508253		520368	

### SQUARE LINK CROSS CHAIN

2-LINK SPACING FOR BETTER TRACTION AND LONGER LIFE.

(11mm)

TIRE SIZE	ITEM #	3/8" LIST	ITEM #	7/16" LIST
13.00 x 24				
14.00 x 24	508229		520367	
16.00 x 24	508235			
17.5 x 25	508230		508238	
20.5 x 25	508244		508243	
23.5 x 25			508214	

Also available with studded cross chain, and with 4-link spacing.

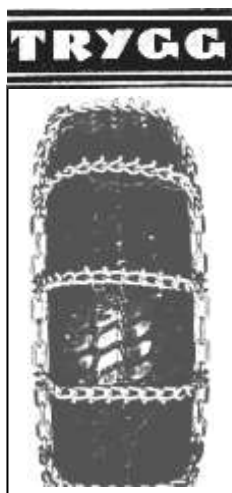

### STUDED CHAIN FOR TRUCKS AND HEAVY EQUIPMENT

#### SINGLE - HEAVY DUTY 4-LINK

TIRE SIZE	ITEM #	5/16"	ITEM #	3/8" LIST
10.00x20, 11x22.5	508334		508390	
10.00x22	508353			
11.00x20	508392			
425 x 65	508315			

#### TRIPLE - HEAVY DUTY 4-LINK

TIRE SIZE	ITEM #	5/16" LIST	ITEM #	3/8' LIST
10.00x20, 11x22.5	508387		508391	
10.00x22, 11x24.5	508349		508337	
11.00x20, 12x22.5	508410		508393	
12 X 24			508419	

PRICES SUBJECT TO CHANGE WITHOUT NOTICE

**SPECIAL ORDERS:** Three measurements are needed to make any size of tire chain

Tire Size appearing on the tire: \_\_\_\_\_

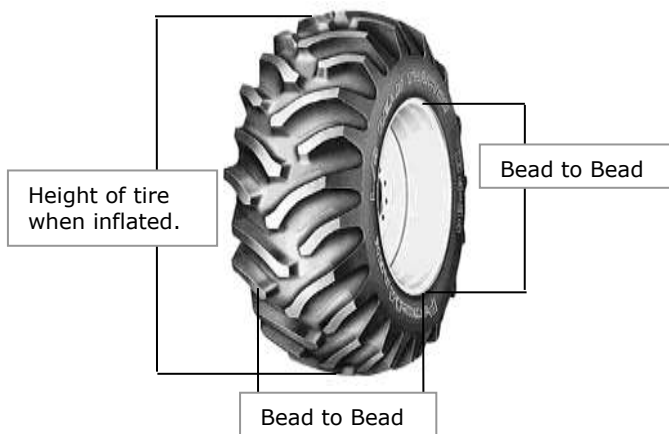

"Bead to Bead" - is a U shaped measurement

Start at bead of rim on one side of tire, up the sidewall, across the tread, down the sidewall, to the bead of the other side of tire.



**HEAD OFFICE** 20 ARTHUR STREET NORTH, ELMIRA, ONTARIO N3B 1Z9  
 TEL: (519) 669-4025 FAX: (519) 669-1436

**ORDER DESK** e-mail: [orders@walcoequipment.com](mailto:orders@walcoequipment.com)  
 TEL: (519) 669-1401 FAX (519) 669-3499

**QUEBEC OFFICE** 364 RTE.122 ST. GERMAIN DE GRANTHAM, QUÉBEC J0C 1K0  
 TEL: (819) 395-5115 Fax (819) 395-2624  
 e-mail: [walcoqc@walcoequipment.com](mailto:walcoqc@walcoequipment.com)

## RING CHAIN

2021

TIRE CHAIN  
 SOLD / SET

### FIXED RING



ITEM #	TIRE SIZE	CHAIN SIZE	LIST PRICE
530150	16.9 x 30	9/16"	
530153	18.4 x 34	5/8"	
530154	23.1 x 26	5/8"	
530156	24.5 x 32	5/8"	
530160	24.5 x 32	3/4"	
530162	30.5 x 32	3/4"	



### MULTI-RING

ITEM #	TIRE SIZE	CHAIN SIZE	LIST PRICE
530165	18.4 x 34	5/8"	
530167	23.1 x 26	5/8"	
530168	24.5 x 32	5/8"	
530177	24.5 x 32	3/4"	
530170	30.5 x 32	5/8"	
530179	30.5 x 32	3/4"	



## STUDED SKIDDER CHAIN

### DOUBLE DIAMOND



ITEM #	TIRE SIZE	CHAIN SIZE	LIST PRICE
530185	18.4 x 34	5/8"	
530186	23.1 x 26	5/8"	
530187	24.5 x 32	5/8"	
530189	30.5 x 32	5/8"	

CHAIN COLOURS MAY NOT BE AS SHOWN

PRICES SUBJECT TO CHANGE WITHOUT NOTICE